

Nominal data

Type	8218 JH4	
Nominal voltage	VDC	48
Nominal voltage range	VDC	20 .. 58
Speed	min ⁻¹	14000
Power input	W	36
Min. ambient temperature	°C	-20
Max. ambient temperature	°C	70
Air flow	m ³ /h	222
Sound power level	B	7.8
Sound pressure level	dB(A)	71

ml = Max. load · me = Max. efficiency · fa = Running at free air · cs = Customer specs · cu = Customer unit
Subject to alterations

Technical features

General description	* Free air power consumption, these values may be considerably higher at the operating point.
Housing material	Fibreglass-reinforced plastic (PBT)
Impeller material	Fibreglass-reinforced plastic (PA)
Mass	0.200 kg
Dimensions	80 x 80 x 38 mm
Direction of air flow	Air exhaust over bars
Direction of rotation	Left, looking at rotor
Bearing	Ball bearings
Lifetime L10 at 40 °C	50000 h
Lifetime L10 at maximum temperature	25000 h
Connection line	Single strands AWG 22, TR 64, bared and tin-plated.
Motor protection	Protected against reverse polarity and locking.
Option	Speed signal

8218 JH4

DC axial compact fan

Product drawing

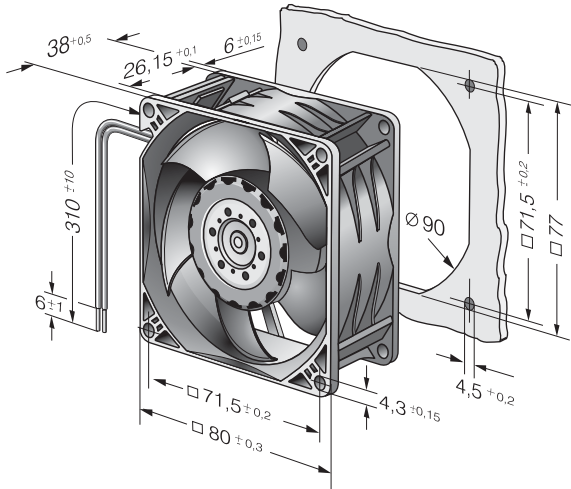

Charts: Air flow

